

Battery Removal:

1. Remove the seat (see page 29) and the side cover (see page 30).
2. Disconnect the negative (-) terminal lead (1) from the battery first.
3. Disconnect the positive (+) terminal lead (2).
4. Remove the battery holder (3) by removing the bolt (4) and nut (5).
5. Pull out the battery from the battery box.

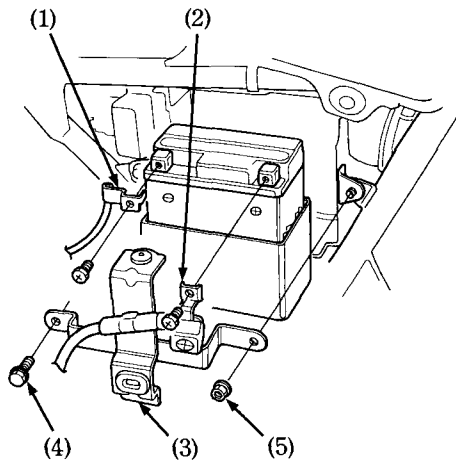

- (1) Negative (-) terminal lead
- (2) Positive (+) terminal lead
- (3) Battery holder
- (4) Bolt
- (5) Nut