

THROTTLE OPERATION

(Refer to the maintenance precautions on page 62).

1. Check for smooth rotation of the throttle grip from the fully open to the fully closed position at both full steering positions.

2. Measure the throttle grip free play at the throttle grip flange.

The standard free play should be approximately:

2.0–6.0 mm (0.08–0.24 in)

To adjust the free play, loosen the lock nut (1) and turn the adjuster (2).

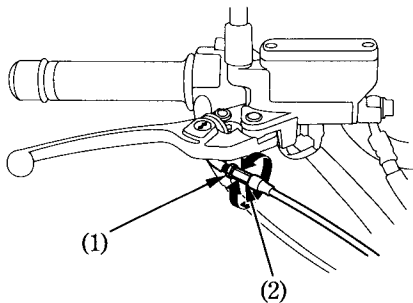

(1) Lock nut

(2) Adjuster