

Compression Damping:

To reduce (SOFT) :

Turn the adjuster counterclockwise toward SOFT for a light load and smooth road condition.

To increase (HARD) :

Turn the adjuster clockwise toward HARD for a firmer ride and rough road condition.

To adjust the adjuster to the standard position, proceed as follows :

1. Turn the damping adjuster (1) clockwise until it will no longer turn (lightly seats). This is the full hard setting.
2. The adjuster is set in the standard position when the adjuster is turned counterclockwise approximately 9 clicks so that its punch mark (2) aligns with the reference punch mark (3).

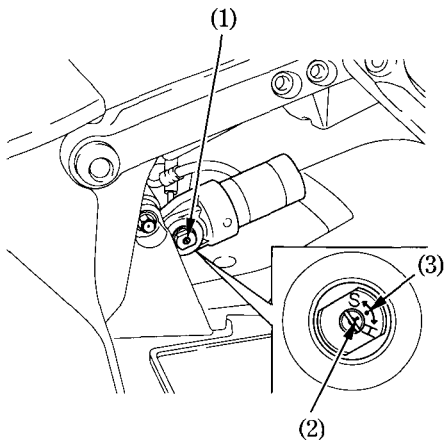

(1) Damping adjuster

(2) Punch mark

(3) Reference punch mark