

Rear Wheel Installation

- To install the rear wheel, reverse the removal procedure.
- Install the side collars into the left and right side wheel hub.
- Make sure that the slot (1) on the swingarm (2) is located in the lug (3) in the brake caliper bracket (4).
- Tighten the rear axle nut to the specified torque:
113 N·m (11.5 kgf·m , 83 lbf·ft)
- Adjust the drive chain (pages 117 – 118).

When installing the wheel, carefully fit the brake disc between the brake pads to avoid damaging the pads.

After installing the wheel, apply the brake several times and then check if the wheel rotates freely. Recheck the wheel if the brake drags or if the wheel does not rotate freely.

If a torque wrench was not used for installation, see your Honda dealer as soon as possible to verify proper assembly. Improper assembly may lead to loss of braking capacity.

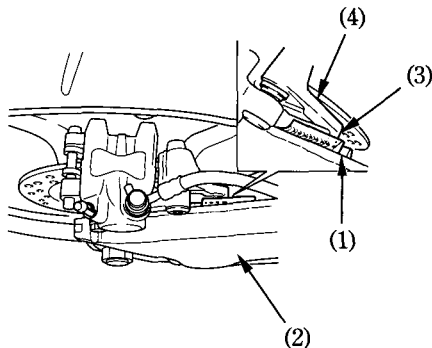

(1) Slot
(2) Swingarm

(3) Lug
(4) Brake caliper bracket