

DRIVE CHAIN SLIDER

Refer to the Safety Precautions on page 78 .

Check the chain slider (1) for wear.
The chain slider must be replaced if it is worn to the wear limit line (2). For replacement, see your Honda dealer.

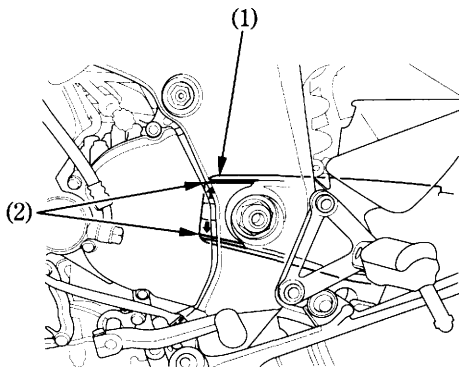

- (1) Chain slider
- (2) Wear limit line