

SIDE STAND

(Refer to the maintenance precautions on page 78).

Perform the following maintenance in accordance with the maintenance schedule.

Functional Check:

- Check the spring (1) for damage or loss of tension and the side stand assembly for freedom of movement.
- Check the side stand ignition cut-off system:
 1. Sit astride the motorcycle; put the side stand up and the transmission in neutral.
 2. Start the engine and with the clutch lever pulled in, shift the transmission into gear.
 3. Lower the side stand. The engine should stop as you put the side stand down.

If the side stand system does not operate as described, see your Honda dealer for service.

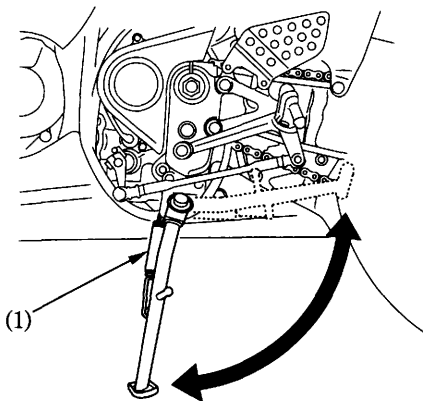

(1) Side stand spring