

Rear Brake Fluid Level:

With the motorcycle in an upright position, check the fluid level. It should be between the UPPER (1) and LOWER (2) level marks. If the level is at or below the LOWER level mark (2), check the brake pads for wear (page 118).

Worn pads should be replaced. If the pads are not worn, have your brake system inspected for leaks.

The recommended brake fluid is Honda DOT 4 brake fluid from a sealed container, or an equivalent.

Rear

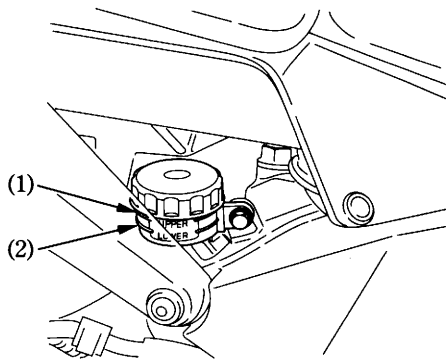

- (1) UPPER level mark
- (2) LOWER level mark