

## FUEL TANK

### Fuel Fill Cap

After refueling, be sure to tighten the fuel fill cap (Fig.2-14) until it clicks.

Insert the breather tube ( 2 ) into the handlebar cover hole ( 3 ).

To refuel refer to page 82 .

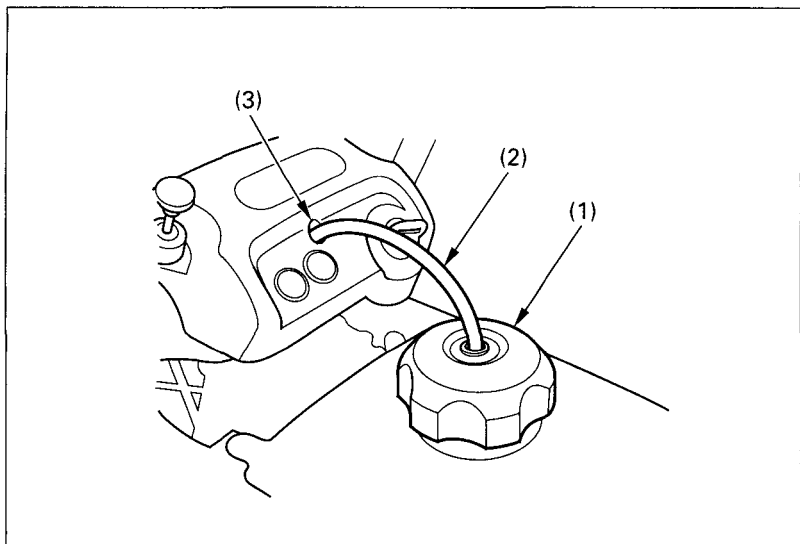

Fig. 2-14 (1) Fuel fill cap

(2) Breather tube  
(3) Handlebar cover hole