

Air Cleaner

- Loosen the screws (5) and remove the air cleaner assembly (6) from the air cleaner housing.
- Unscrew the clamp (7).
- Remove the air cleaner (8) from the air cleaner body (9).
- Gently wash the air cleaner in clean, non-flammable (high flash point) solvent such as kerosene — not gasoline. After cleaning, gently squeeze out the remaining solvent. Avoid twisting or wringing the air cleaner. This can tear the foam.
- Inspect for tears or cracks in the foam or seams of the air cleaner. Replace the air cleaner if it is damaged.
- Allow the air cleaner to dry thoroughly before applying oil. A wet air cleaner will not fully absorb the oil.
- Pour clean Pro Honda Foam Filter Oil or an equivalent (Canada: Honda Foam Filter Oil or an equivalent) over the entire surface of the air cleaner. Use both hands to evenly spread the oil into the air cleaner. Gently squeeze out any excess oil. (To keep your hands dry, place the air cleaner in a clean plastic bag before spreading the oil into the air cleaner.)

UNDER SEAT

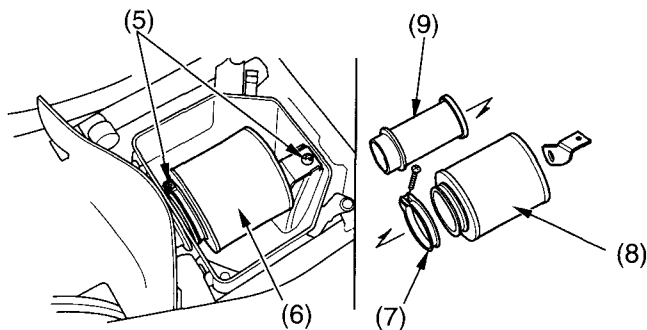

- (5) screws
(6) air cleaner assembly
(7) clamp

- (8) air cleaner
(9) air cleaner body