

NOTE:

If a torque wrench was not used for installation, see your authorized Honda dealer before operating the vehicle to verify proper assembly.

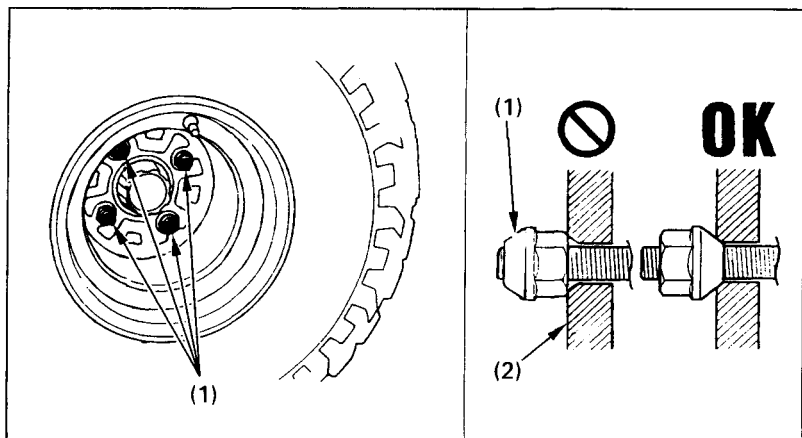

Fig. 4-30 (1) Wheel nuts

(2) Wheel rim

TIRES

This FOURTRAX is equipped with low pressure tubeless tires. Although the tires are designed specifically for off-road use, they are not immune to punctures. Always select your riding area with care.

Tire Pressure

Check the tire pressure frequently with the air pressure gauge supplied with the vehicle. For normal use, the tires should be inflated to the pressure recommended in Fig. 4-31.

NOTE:

- * Tire pressure should be checked before you ride, when the tires are "cold." Be sure to check tire pressure at the riding site, since changes in altitude can affect air pressure.
- * A manually operated tire pump should be used rather than the high pressure systems found in service stations. This will minimize the possibility of tire damage from overinflation. If you use a high pressure system at a service station, add air in small amounts and check the pressure increase frequently to prevent possible tire damage from overinflation.