

To adjust the free play, turn the brake pedal adjusting nut (Fig. 4-28), located on the brake operating rod at the rear of the frame.

NOTE:

Make sure the cut-out on the adjusting nut is properly seated on the brake arm pin (3).

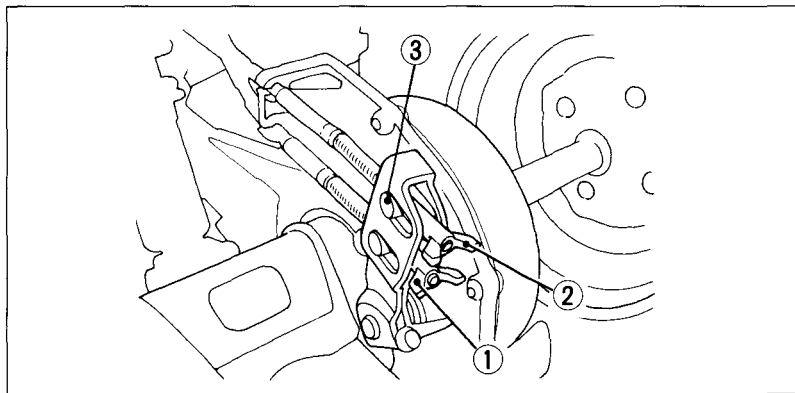

Fig. 4-28

- (1) Brake pedal adjusting nut
- (2) Brake lever adjusting nut
- (3) Brake arm pin