

Choke Lever

The choke lever (Fig. 2-7) is next to the starter button. The choke has three positions: fully ON (A), halfway position (B), and fully OFF (C).

To start a cold engine when air temperature is 10–35°C (50–90°F), move the choke lever left to the half way position before pressing the starter button. At colder air temperatures, set the choke to fully ON position before pressing the starter button. As the engine warms, move the lever to the halfway position. After the engine is warm, move the choke right to the fully OFF.

CAUTION:

Extended use of the choke may impair piston and cylinder wall lubrication and shorten the life of the engine.

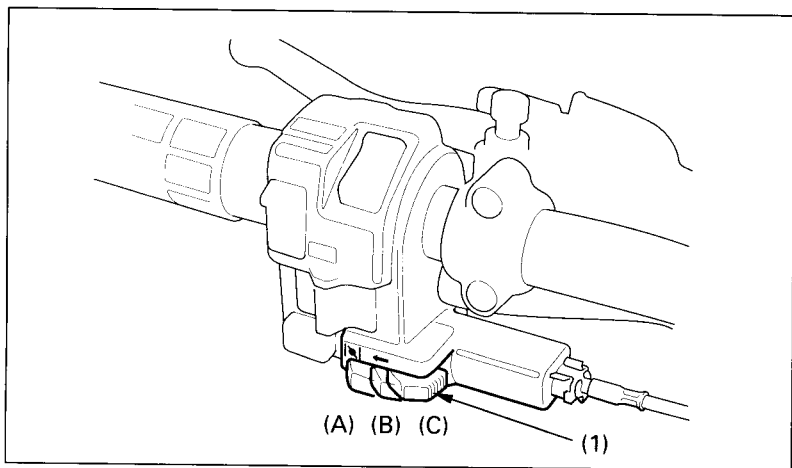

Fig. 2-7 (1) Choke lever

(A) Fully ON
(B) Halfway position
(C) Fully OFF