

FUSE

As illustrated in Fig. 4-21, the main fuse (1), the sub fuse (2) and the spare fuse (3) are located in the battery compartment. (The main fuse is connected to the red wire.)

The specified fuse is:

15 A

If a fuse fails frequently, it usually indicates a short circuit or an overload in the electrical system. See your authorized Honda dealer for repair.

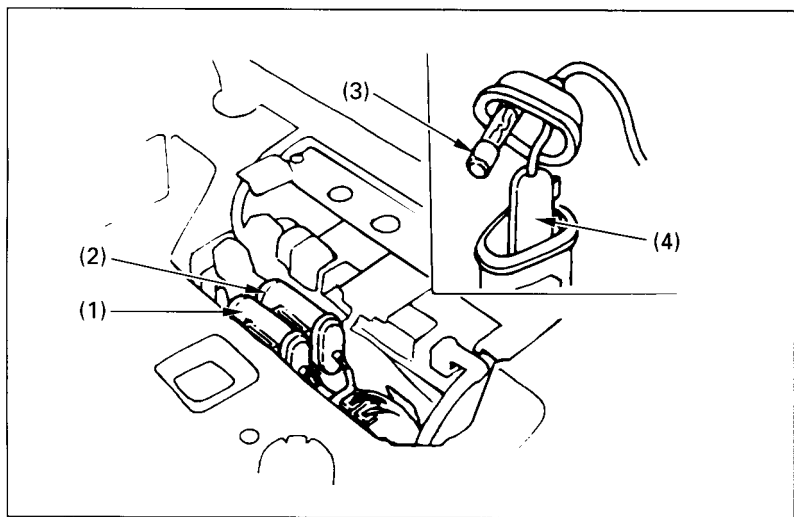

Fig. 4-21 (1) Main fuse (Red wire)
(2) Sub fuse (Pink wire)

(3) Spare fuse
(4) Fuse holder