

## Flag Pole Bracket

The flag pole bracket (Fig. 2-29) is on the rear cargo rack. Flag poles are optional equipment available from your Honda dealer. To mount a pole in the bracket, follow the instructions that come with the flag pole kit.

### NOTE:

Flag poles are required in some riding areas. Check local regulations before riding.

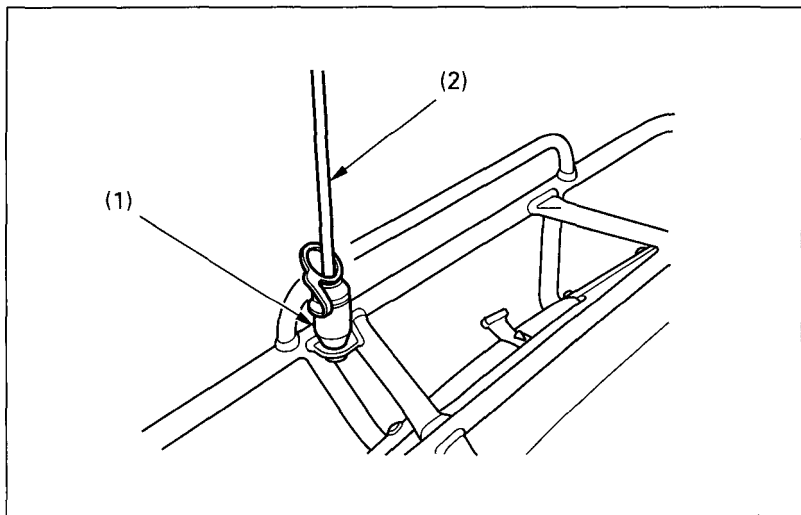

Fig. 2-29 (1) Flag pole bracket

(2) Optional flag pole