

- (20) Accessory socket
- (21) Fuel valve
- (22) Starting primer knob
- (23) Storage compartment, containing:
  - Tool kit
  - Air pressure gauge
  - Owner's Manual
- (24) Oil filler cap
- (25) Gearshift pedal
- (26) Left footpeg
- (27) Trailer hitch

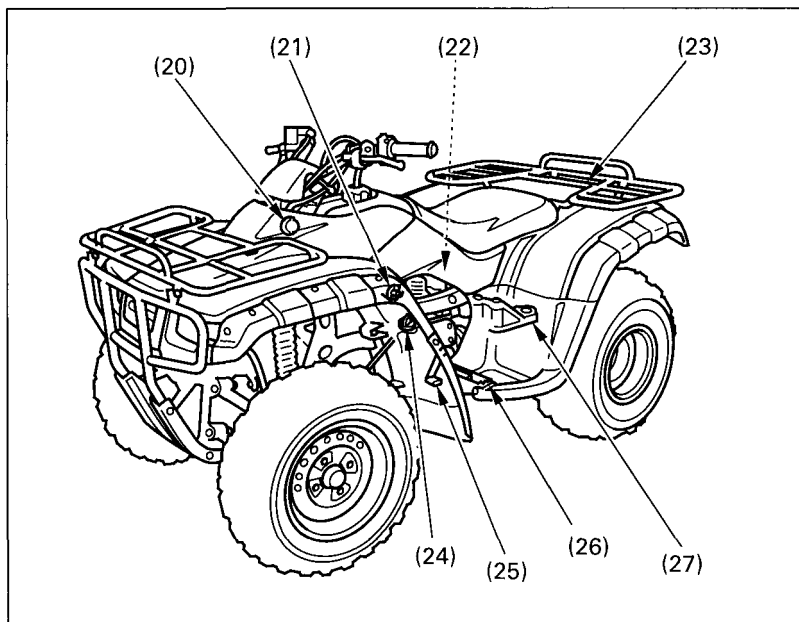

Fig. 2-3

Left side of FOURTRAX