

To adjust the free play, turn the brake pedal adjusting nut (1), (Fig. 4-29), located on the brake operating rod at the rear of the frame. Make sure the cut-out on the adjusting nut is properly seated on the brake arm pin (3).

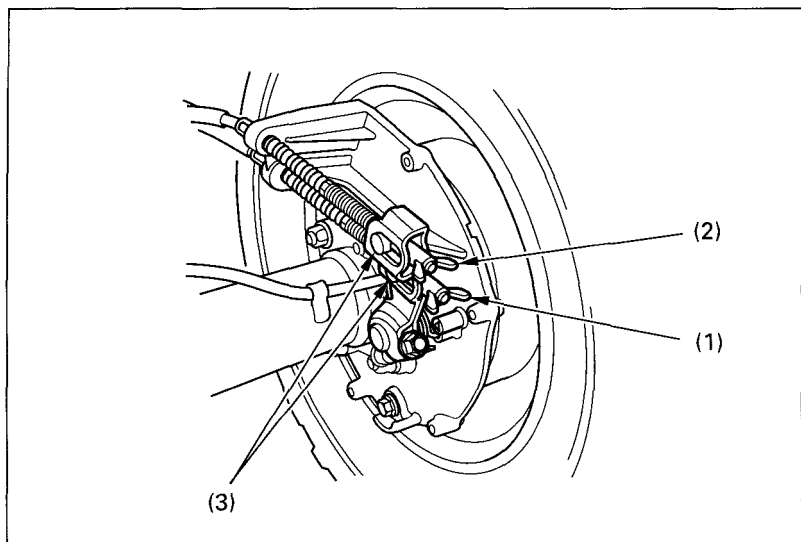

Fig. 4-29 (1) Brake pedal adjusting nut
(2) Brake lever adjusting nut
(3) Brake arm pin