

Brakes

Fluid Level Inspection

Refer to *Safety Precautions* on page 87 .

RIGHT HANDLEBAR

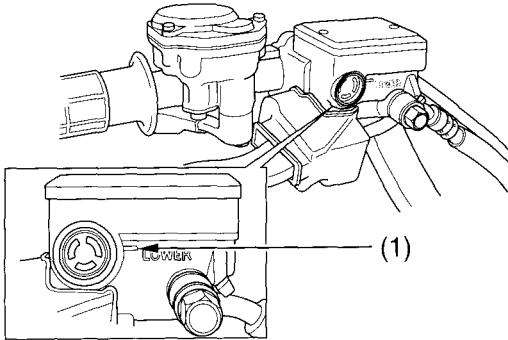

(1) LOWER level mark

If your inspection indicates a low fluid level, have your Honda dealer add the recommended fluid.

Do not add or replace brake fluid, except in an emergency. If you do add fluid, have your Honda dealer check the system as soon as possible.

NOTICE

Brake fluid can damage plastic and painted surfaces. Handle with care.