

# Owner's Manual Storage

---

Your ATV provides storage for the owner's manual so you'll have it with you for easy reference. Store your owner's manual (1) in the tray (2) attached to inside of the storage compartment (3). The storage compartment is below the rear cargo rack.

To open the tool box lid and pull down the tray see pages 98 , 99 . The owner's manual and air pressure gauge (4) should be stored in the tray.

Be careful not to flood this area when washing your ATV.

## REAR

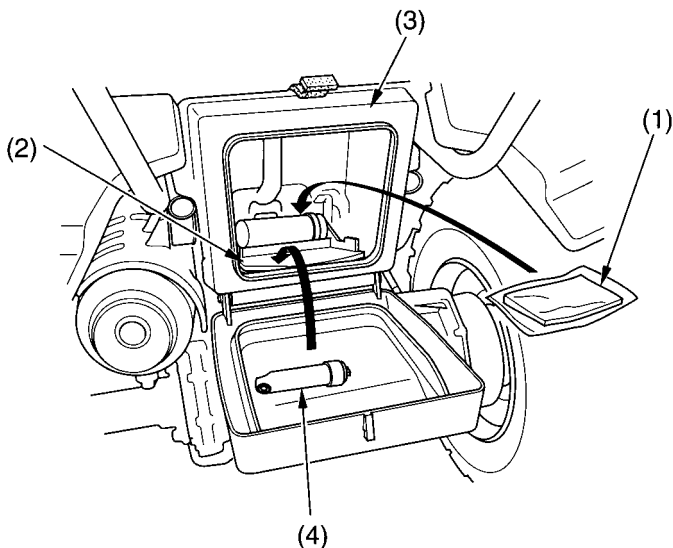

(1) owner's manual  
(2) tray

(3) storage compartment  
(4) air pressure gauge