

# Seat Removal

Refer to *Safety Precautions* on page 87 .

The seat must be removed for the air cleaner, battery and fuse maintenance.

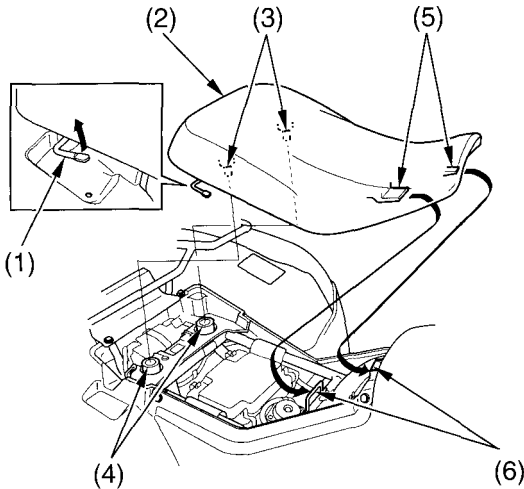

- (1) seat lock lever
- (2) seat
- (3) studs

- (4) grommets
- (5) front prongs
- (6) hooks

## Removal

1. Pull the seat lock lever ( 1 ) at the right side of the seat.
2. Pull the seat ( 2 ) up from the rear to remove the studs ( 3 ) from the grommets ( 4 ).
3. Slide the seat back and up.

## Installation

1. Insert the front prongs ( 5 ) into the hooks ( 6 ) on the frame and press the studs into the grommets.
2. Press down on the seat until locks.