

## DRAINING WATER FROM BRAKES

Make sure the engine is off and the parking brake is set. Then remove the inspection hole plug (Fig. 4-30) from the front brakes, and the drain bolt (Fig. 4-31) from the bottom of the rear brake cover. If any water drains, the brake seals must be replaced by your Honda dealer as soon as possible.

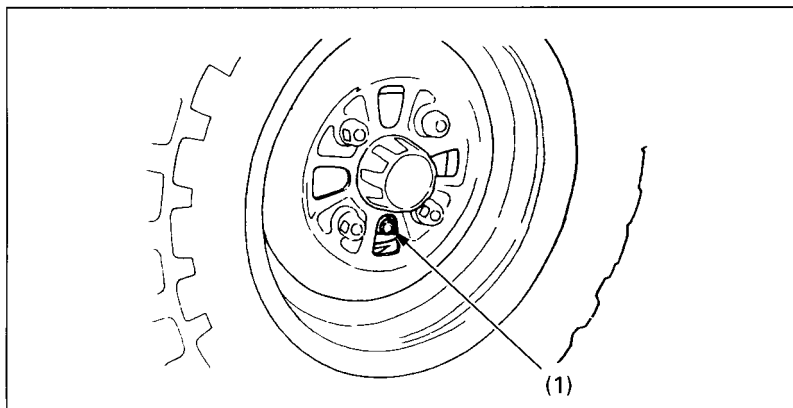

Fig. 4-30

(1) Front brake inspection hole plug

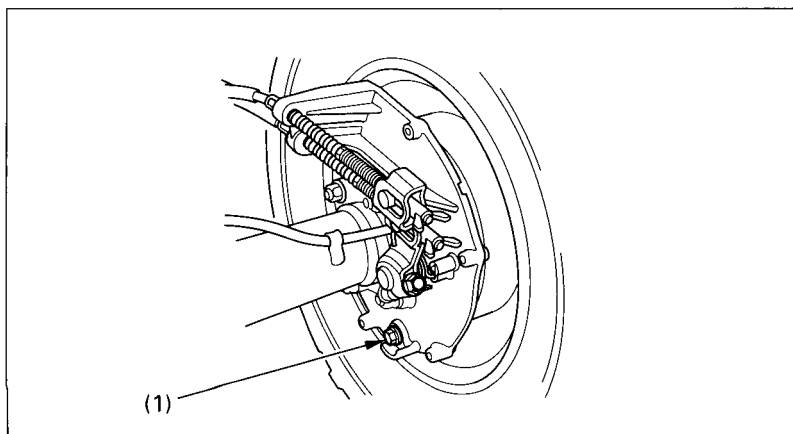

Fig. 4-31

(1) Rear brake drain bolt