

## BRAKES

### FRONT BRAKES

This FOURTRAX has hydraulic front drum brakes on both front wheels. Each day before riding you should check the brake lever free play and inspect the system for fluid leaks. The brake fluid level should be checked frequently, and the brake shoe linings should be inspected periodically.

To check lever free play and shoe lining clearance:

1. Measure the distance the brake lever (Fig. 4-23) moves before the brakes start to take hold. Free play, measured at the tip of the front brake lever (1) should be within 1—1-1/4 in (25—30 mm).

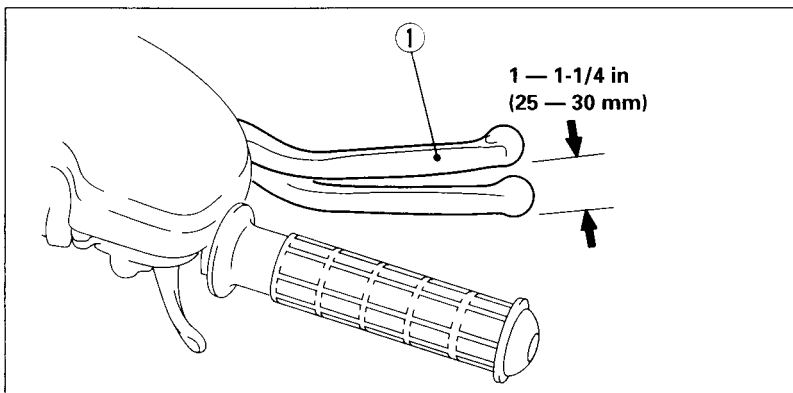

Fig. 4-23

(1) Front brake lever