



Spark Plug

Spark Plug Recommendation

standard spark plug	BKR5E-11 (NGK) or K16PR-U11 (DENSO)
---------------------	--

Use only the recommended type of spark plug in the recommended heat range.

NOTICE

Using spark plugs with an improper heat range can cause engine damage.

Spark Plug Inspection & Replacement

Refer to *Safety Precautions* on page 89 .

1. Remove the seat (page 100) and left side cover (page 108).
2. Remove the left tank side cover (1) by removing the bolts (2).

LEFT SIDE

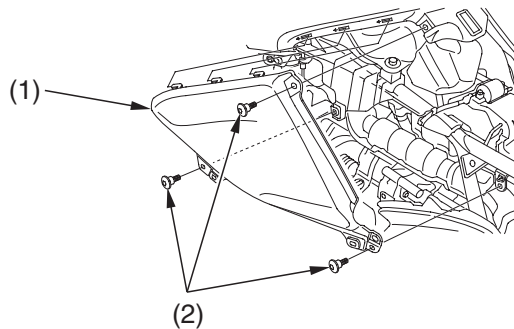

(1) left tank side cover

(2) bolts