

LIGHTS

Headlight and Dimmer Switches

The headlight and dimmer switches (Fig. 2-12) are above the engine stop switch, next to the left handgrip.

Turning the headlight switch (1) ON (☼) turns the headlight and assist headlight on. Use the dimmer switch (2) to select either high beam HI (≡D) or low beam LO (≡D) for the headlights.

The dimmer switch will not change the assist headlight beam.

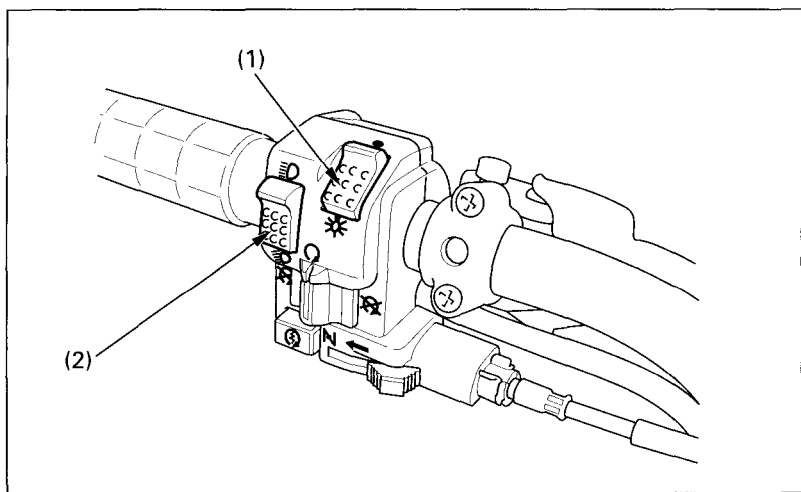

Fig. 2-12 (1) Headlight switch

(2) Dimmer switch