

## Engine Stop Switch

The engine stop switch (Fig. 2-6 ) is next to the left handgrip, and it has three positions. When the switch is in the ○ (RUN) position, the engine will operate. When the switch is in either ☒ (OFF) position, the engine will not operate.

This switch is intended primarily as a safety or emergency control, and it should normally remain in the ○ (RUN) position.

### NOTE:

If you stop your FOURTRAX by turning the engine stop switch ☒ (OFF), be sure to turn the ignition switch ○ (OFF) to prevent battery discharge.

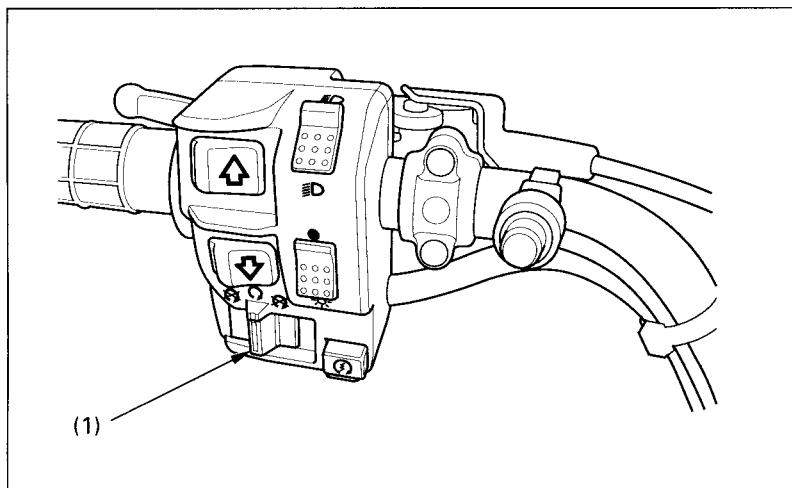

Fig. 2-6

(1) Engine stop switch