

# Engine Oil & Filter

2. Remove the oil filter cover (3) by removing the bolts (4). Let the remaining oil drain out. Discard the oil filter (5) in an approved manner (page 178).
3. Check that the oil filter cover O-rings (6) are in good condition and then install a new oil filter. Use only the Honda genuine oil filter or a filter of equivalent quality specified for your model. Using the wrong Honda filter or a non-Honda filter which is not of equivalent quality may cause engine damage.
4. Reposition the spring (7) to the engine crankcase and install a new oil filter with the rubber seal (8) facing out, away from the engine. You will see the "OUTSIDE (TOWARDS FILTER COVER)" mark (9) on the filter body, near the seal.

## NOTICE

*Improper installation of the oil filter can cause serious engine damage.*

### RIGHT SIDE

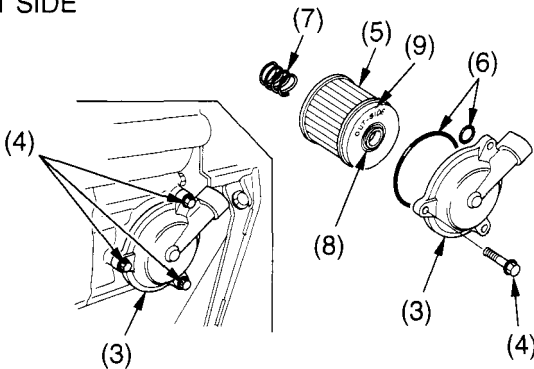

- (3) oil filter cover
- (4) bolts
- (5) oil filter
- (6) O-rings

- (7) spring
- (8) rubber seal
- (9) OUTSIDE mark

(cont'd)