

Brakes

Brake Pad Wear

Refer to *Safety Precautions* on page 81.

Brake pad wear will depend upon the severity of usage and riding conditions. The pads will wear faster in wet or muddy conditions. Inspect the pads visually during all regular service intervals to determine the pad wear.

RIGHT FRONT (Left side similar)

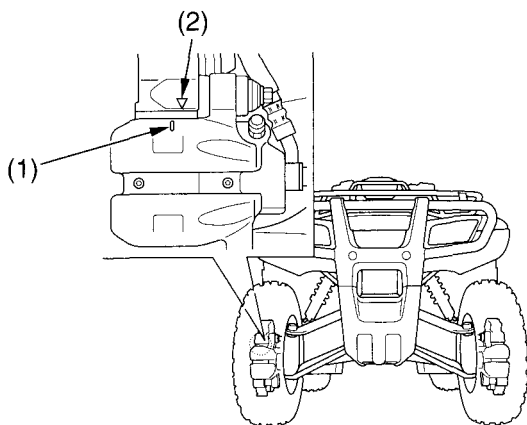

(1) wear indicator

(2) reference mark

Check the wear indicator (1). Remove the front wheels (page 170). If the wear indicator aligns with the reference mark (2), both pads must be replaced, see your Honda dealer for this replacement.

Always inspect both pads in both the right and left front brake calipers.