

ENGINE OIL

Engine Oil Level Check

Check the engine oil level each day before riding the motorcycle.

The level must be maintained between the upper (2) and lower (3) level marks on the dipstick (1).

1. Start the engine and let it idle for a few minutes. Make sure the low oil pressure indicator goes off. If the light remains on, stop the engine immediately.
2. Stop the engine and hold the motorcycle in an upright position on firm, level ground.
3. After a few minutes, remove the dipstick, wipe it clean, and reinsert the dipstick without screwing it in. Remove the dipstick. The oil level should be between the upper and lower marks on the dipstick.
4. If required, remove the oil filler cap (4) and add the specified oil (see page 63) up to the upper level mark. Do not overfill.

5. Reinstall the dipstick and oil filler cap. Check for oil leaks.

CAUTION:

*** Running the engine with insufficient oil can cause serious engine damage.**

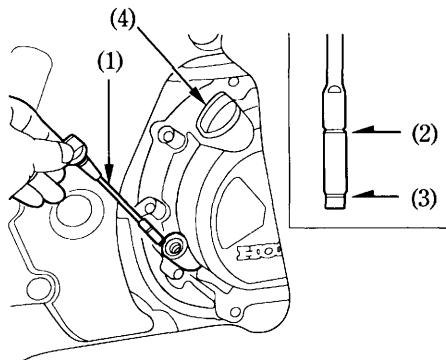

- | | |
|----------------------|----------------------|
| (1) Dipstick | (3) Lower level mark |
| (2) Upper level mark | (4) Oil filler cap |