

STOPLIGHT SWITCH ADJUSTMENT

(Refer to the maintenance precautions on page 55).

Check the operation of the stoplight switch (1) at the right side behind the engine from time to time.

Adjustment is done by turning the adjusting nut (2). Turn the nut in the direction (A) if the switch operates too late and in direction (B) if the switch operates too soon.

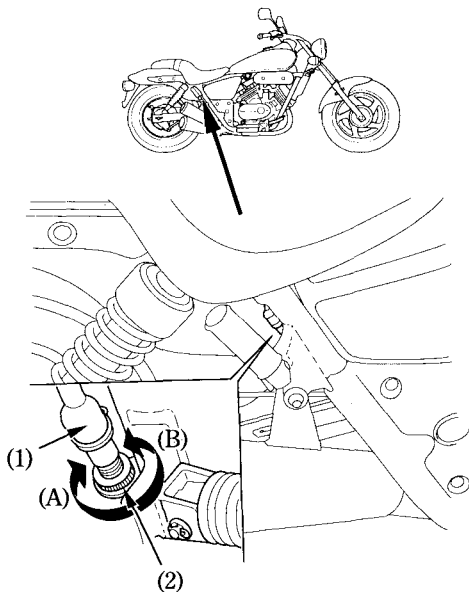

(1) Stoplight switch

(2) Adjusting nut