

## RIGHT HANDLEBAR CONTROLS

### Engine Stop Switch

The engine stop switch (1) is next to the throttle grip. When the switch is in the RUN position, the engine will operate. When the switch is in the OFF position, the engine will not operate. This switch is intended primarily as a safety or emergency switch and should normally remain in the RUN position.

### Headlight Switch (Except U type)

The headlight switch (2) has three positions; "H", "P" and "OFF" marked by a red dot to the left of "P".

H: Headlight, taillight, position light and meter lights on.

P: Position light, taillight and meter light on.

OFF(dot): Headlight, taillight, position light and meter lights off.

### Starter Button

The starter button (3) is below the headlight switch (2).

When the starter button is pressed, the starter motor cranks the engine. See page 37 for the starting procedure.

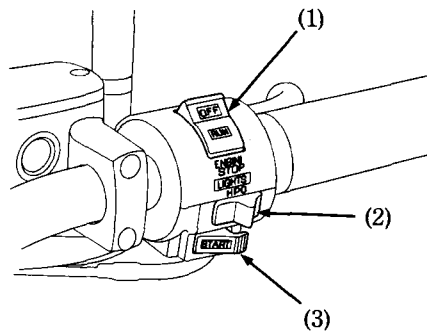

- (1) Engine stop switch
- (2) Headlight switch
- (3) Starter button