

THROTTLE OPERATION

Refer to the Safety Precautions on page 74 .

1. Check for smooth rotation of the throttle grip from the fully open to the fully closed position at both full steering positions.
2. Measure the throttle grip freeplay at the throttle grip flange.
The standard freeplay should be approximately:
2–6 mm (0.08–0.24 in)

To adjust the freeplay, loosen the lock nut (1) and turn the adjuster (2).

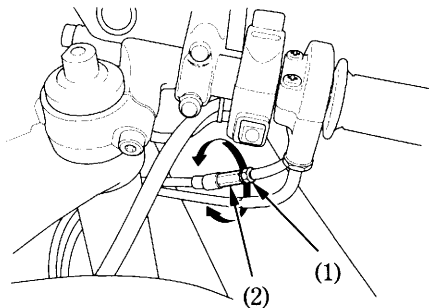

(1) Lock nut

(2) Adjuster