

Reverse Lock System

Reverse Lock System Adjustment

Refer to *Safety Precautions* on page 99 .

LEFT HANDLEBAR

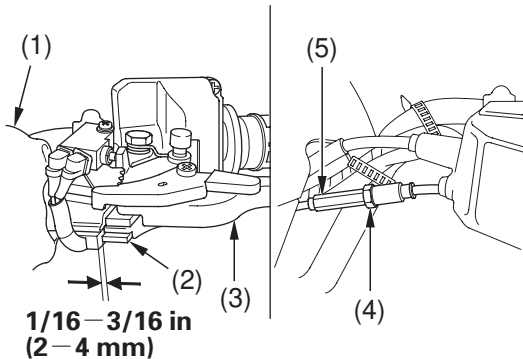

- | | |
|--------------------------|-------------------|
| (1) dust cover | (4) lock nut |
| (2) reverse assist lever | (5) adjusting nut |
| (3) rear brake lever | |

1. Pull back the dust cover (1).
2. Check the reverse assist lever (2) freeplay, measured at the rear brake lever (3) end near the cable:
 $1/16 - 3/16$ in (2 - 4 mm)
3. To adjust, loosen the lock nut (4) and turn the adjusting nut (5).
After adjustment, tighten the lock nut securely.
4. Return the dust cover.

Other Checks

Check the reverse assist lever and cable for loose connections or other damage. If the cable is worn or kinked, have it replaced by your Honda dealer.